



SCHEDA TECNICA - *Technical data sheet*



Modello-Model: **MAXIVAREM LS**

Codice-Code: **US 300 461**



Capacità Capacity	Codice Code	Press. Max bar	Raccordo Connector	Dimensioni Dimensions					Peso Weight Kg.	Imballo Packaged Volume m3	
				∅	A	B	C	D			E
300 L	US 300 461	10 bar	1"1/2 gas	630	1400	1080	1000	175	-	54	0,63

Parti di ricambio - *Spare parts*

Controflangia Coverflange		
Codice-Code:	V50300	
Materiale-Material:	FE	
Trattamento-Treatment:	Verniciata-Painted	
Membrana Membrane		
Codice-Code:	V42300	
Materiale-Material:	Gomma BUTILE	
Trattamento-Treatment:		
Controfl. Superiore Top flange		
Codice-Code:	V50301	
Materiale-Material:	FE	
Trattamento-Treatment:	Zincata-Galvanized	
Dado Nut		
Codice-Code:	V50880	
Materiale-Material:	FE	
Trattamento-Treatment:	Zincato-Galvanized	
Valvola Pre carica Precharge valve		
Codice-Code:	V50802	
Materiale-Material:	Ottone - Brass	

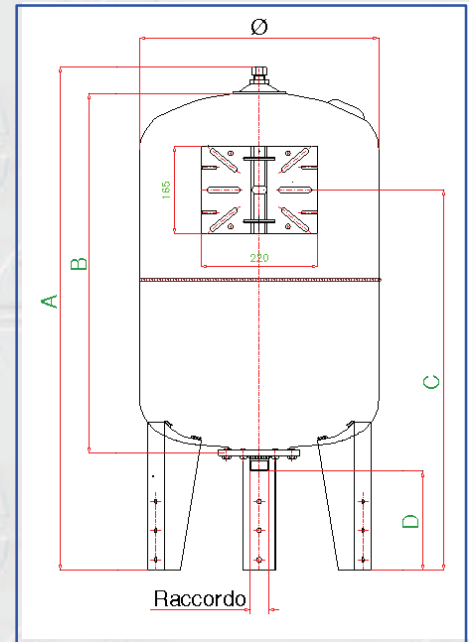

Dimensioni Scatola -
Dimensions box:

A=1440 B=665 H=670

